

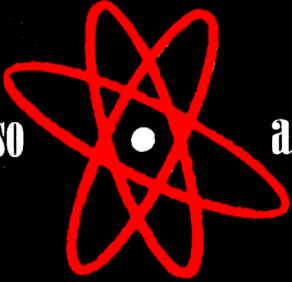

MORE ABOUT POWER SUPPLIES

TWO 250 MA PLATE POWER SUPPLIES
WITH EXCELLENT DYNAMIC CHARACTERISTICS

also



a power control unit

In the previous issue of G-E HAM NEWS we presented a discussion of the dynamic characteristics of plate power supplies ordinarily used with amateur transmitters and modulators—together with some design notes on how to improve said dynamic characteristics.

Here are two power supplies designed and constructed in such a way as to not only obtain unusually good dynamic regulation but also to keep cost to a minimum. To fully appreciate these two designs, we suggest you review the previous article. If you can't beg or borrow a copy of our January-February issue (Volume 9, No. 1), drop me a card.

— *Lighthouse Larry*

Contents

Two 250 MA Plate Power Supplies.....	Page 2
Power Control Unit.....	Page 6
Sweeping the Spectrum.....	Page 7
Technical Information—6AV5.....	Page 8

two power supplies

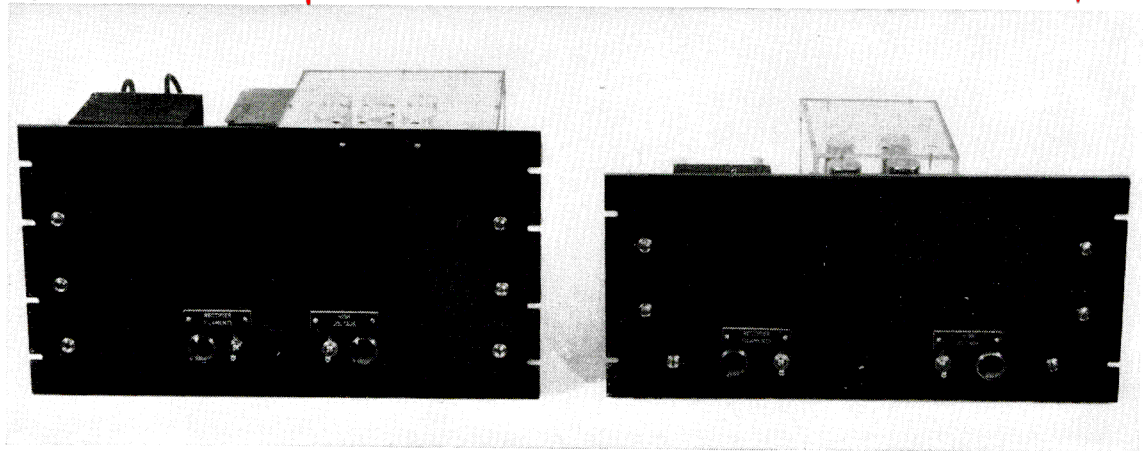

1500 VOLT

750 VOLT

The dynamic characteristics of the average amateur power supply are those characteristics which become apparent in the operation of the supply when it is in actual use under average amateur operating conditions. In most amateur operations this means rapid intermittent application and removal of widely varying loads.

Meters will not measure the extensive voltage drops and peaks which are induced by varying the load—and as a result it has become somewhat traditional to regard such voltage excursions as “instantaneous” and “of little consequence.”

However, as demonstrated in the tests reported in the last issue of G-E HAM NEWS, these voltage excursions are somewhat more serious than is generally believed. The oscillograms showed that when normal load is applied d-c output voltage will drop to as low as a third of the no-load voltage, then wildly overshoot the no-load level, drop again, and so on—even in a power supply which has an acceptable static regulation figure.

Instantaneous oscillations? That depends on the definition of the word *instantaneous*. As these oscillations were actually photographed on an oscilloscope along with a 60-cycle timing wave, it was shown that the transient oscillations lasted well over a tenth of a second—enough time to competently modulate every CW character and distort at least a fair portion of the first syllable of every word a phone man utters.

Experiments showed the oscillations were directly related to the resonant frequency of the power supply filter—and that the simplest solution to the problem was to lower the resonant frequency by adding capacity to the filter. It was found that addition of sufficient capacity would smooth out the dynamic regulation curve so that it would nearly coincide with the conventional static regulation curve of the supply.

However, high-voltage oil capacitors cost money—lots of it. In order to economize, at least in the sense of

not running these newly designed power supplies a great deal higher in cost than conventional supplies of the same ratings, electrolytic capacitors have been specified in series-parallel combinations together with voltage-equalizing resistors.

Electrolytic capacitors generally are, we believe, better than they are cracked up to be in amateur circles. True, they may not last as long as oil capacitors, but as they have been improved considerably since first introduced, it was felt they were well worth trying. Those who still feel squeamish about using electrolytics may, of course, put in oil capacitors of the same value with equally good results. However, it is felt the electrolytics offer more capacity per year, per dollar.

In obtaining the unusually high capacity via the series-parallel methods shown in the circuit diagrams, it is important to make sure that all the equalizing resistors are used. This will insure operation of each capacitor well within its voltage rating.

The can of each electrolytic capacitor is its negative terminal. The capacitors in the series arrangement at the negative (chassis) end of the string may be mounted directly on the chassis with the metal mounting rings supplied with each capacitor. However, the remaining capacitors must be installed with cans insulated not only from the chassis but also insulated from the cans of the capacitors higher up in the string. Careful examination of the circuit diagrams will make this clear.

To provide this insulation a variety of mounting methods will suggest themselves to the builder. The method shown here is to mount capacitors that must be insulated on a piece of textolite which in turn is mounted in a hole of appropriate size cut in the chassis.

In addition, it is strongly recommended that a shield be placed over those capacitors whose cans operate above ground. *This shield is to protect the operator—not the capacitors!* Remember that the can of an electrolytic capacitor is generally thought of, subconsciously, as being grounded. The builder may have

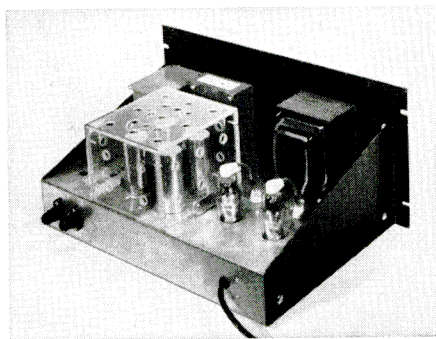
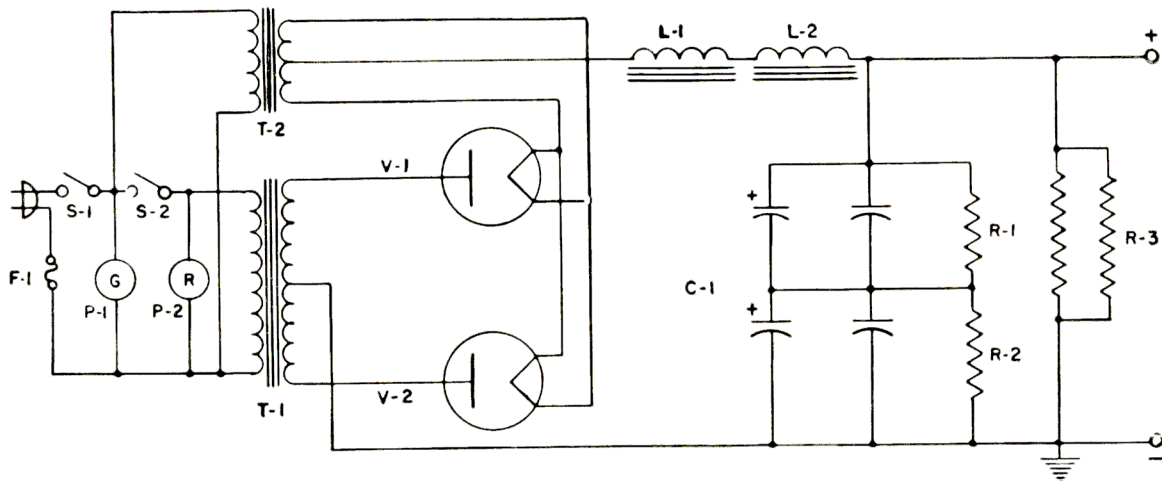
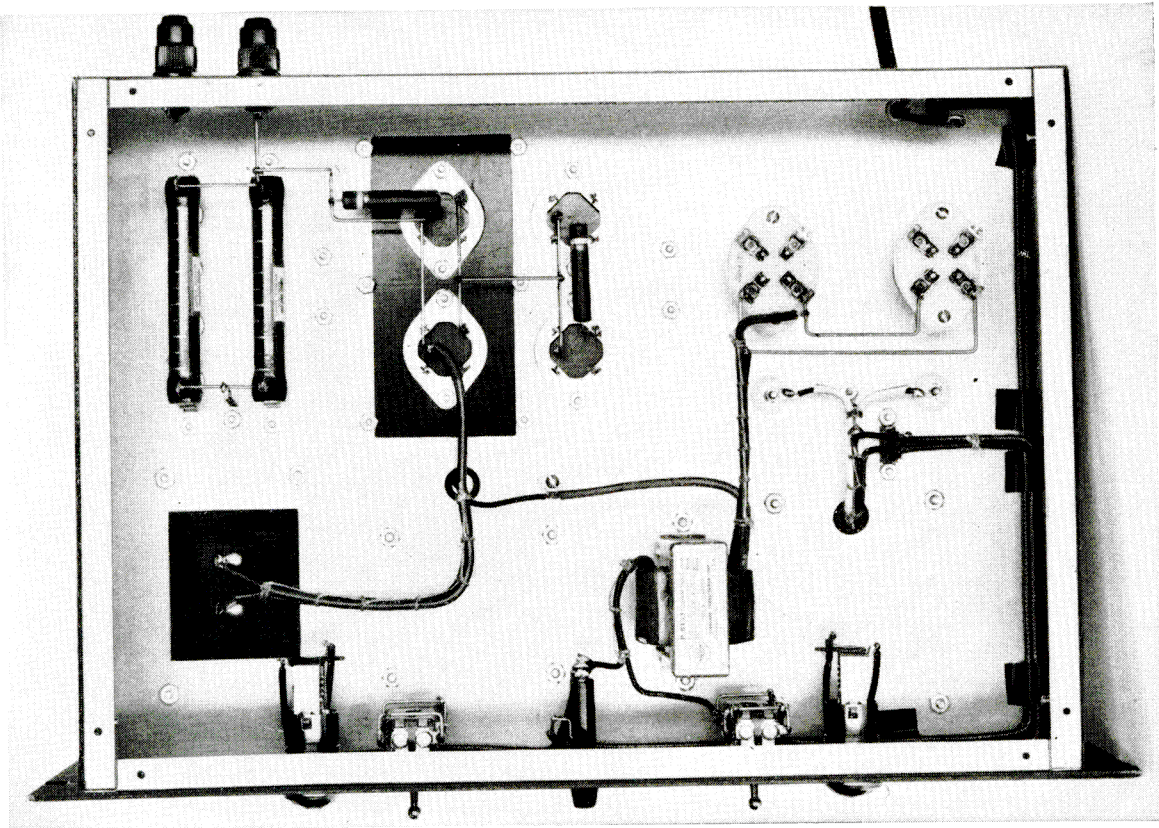

750 v/250 ma Power Supply

- S₁, S₂—SPST toggle switch (preferably power type, 12A)
- T₁—920-0-920 plate transformer (Stancor PC-8305)
- T₂—2.5 v, 5A filament transformer (Stancor P-6133)
- V₁, V₂—GL-816
- L₁—20/4 h at 30/300 ma, 80 ohms D-C resistance swinging choke (Stancor C-1720)
- L₂—20 h, 225 ma smoothing choke (UTC S-31)
- C₁—125 or 90 mfd (4 Sprague TVL-1760 or 1850)
- R₁, R₂—200,000 ohms, 2 w composition
- R₃—50,000 ohms, 25 w (see text)
- P₁, P₂—110 v pilot lamp
- F₁—5A slow-blowing fuse

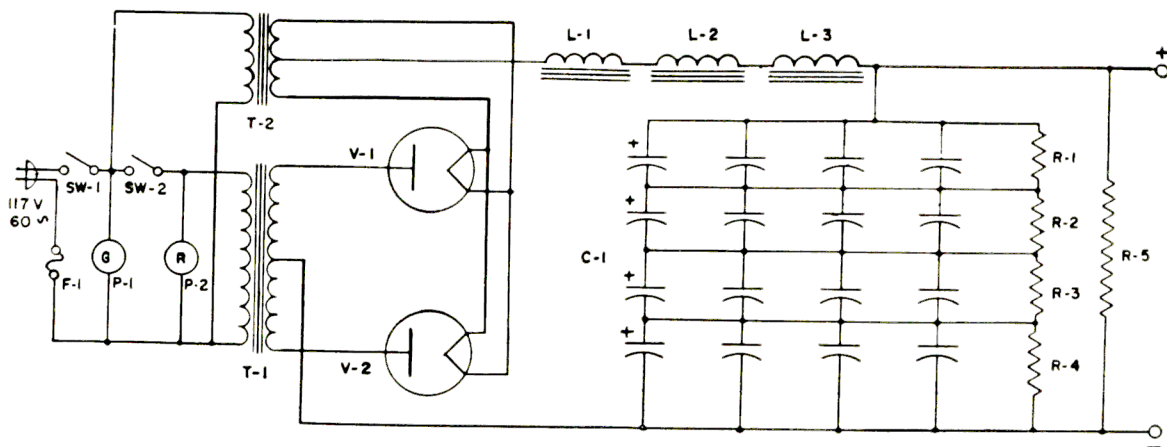
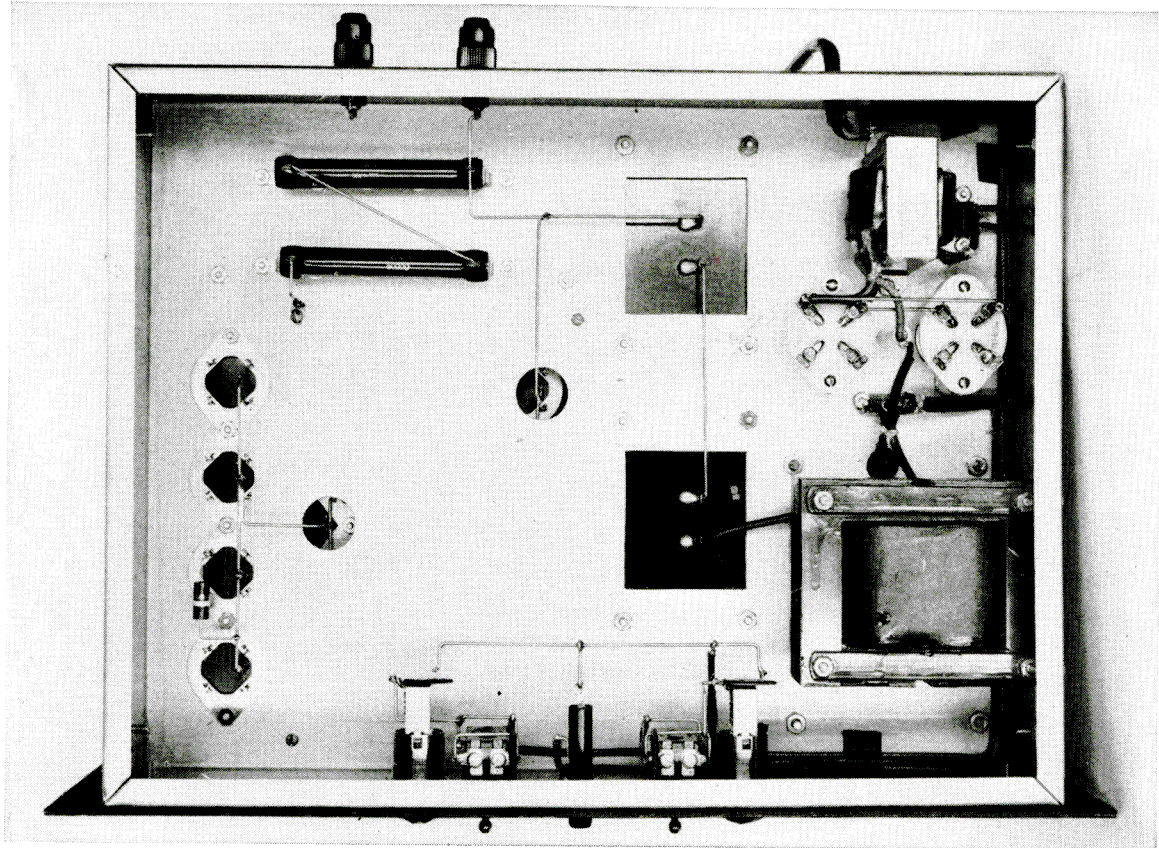

1500 v/250 ma Power Supply

- S_1, S_2 —SPST toggle switch (power type, 12A)
 T_1 —1790-0-1790 plate transformer (Stancor PT-8314)
 T_2 —2.5 v 5A filament transformer (Stancor P-6133)
 V_1, V_2 —GL-816
 L_1 —20/4 h at 30/300 ma, 80 ohms D-C resistance swinging choke (Stancor C-1720)
 L_2, L_3 —20 h, 225 ma smoothing choke (UTC S-31)
 C_1 —125 or 90 mfd (16 Sprague TVL-1760 or 1850)
 R_1, R_2, R_3, R_4 —100,000 ohms, 2 w composition
 R_5 —100,000 ohms, 50 w (see text)
 P_1, P_2 —110 v pilot lamp
 F_1 —10A slow-blowing fuse

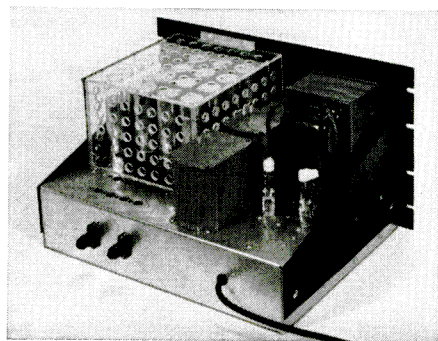

the danger fresh in his mind while he is constructing the power supply and for a relatively short time thereafter. But will he remember, say, a year from now when he opens the rig to service some component that some of those cans are well above ground? And will a visitor to the shack—or the junior operator—inquisitively poking around inside the supply, ever know—even *after he touches one*—that those cans are “hot”?

Take no chances! Time and effort taken *now* to build a shield for these above-ground cans can save a life in the future. The shields shown were fashioned out of sheets of plexiglass drilled with ventilation holes. Such refinement is not necessary, of course. Shields can be fabricated from almost any type of metal. Hardware cloth is inexpensive, easy to handle and when corner joints are soldered it makes a fairly solid shield.

While the sixteen capacitors in the 1500-volt supply may seem like a staggering number, this amounts only to a bank of four-by-four which can occupy as little space as an eight-inch square. Actually, of course, only 12 of these have to be insulated from the chassis.

Remember, the more output capacity, the better the dynamic performance of the power supply will be. If possible, it will be best to use the 125-microfarad capacitors (Sprague TVL 1760, or equivalent). As demonstrated in the previous article, it is difficult to see how one can get too much capacity built into the power supply.

On the other hand, it is important not to overdo the inductance, since the static regulation is proportional to the total d-c resistance of the chokes.

A word about the fact that 225-milliamperere smoothing chokes are here used in 250-milliamperere power supplies. In a search for chokes of the lowest possible cost and d-c resistance, the design work proceeded on the assumption that the published rating meant, in effect, that this choke has 20 henries inductance at a 225-milliamperere load—and might very likely carry additional current. As a test, three of these chokes were put under continuous 250-milliamperere loads for 24 hours with no adverse effects. Few amateurs run their power supplies at the so-called “maximum” ratings, but those who regardless of the foregoing wish to put in chokes of higher current rating and are willing to pay the additional cost can do so. The chokes specified in the accompanying circuits were chosen with this in mind—that is, to get as high inductance and as low resistance as possible at the lowest possible cost. If other chokes than those specified are used, the resistance should be checked.

A word about the bleeder resistors used in these two power supplies. To run the resistors as cool as possible, provide a maximum of safety and save space, two methods were tried. In the smaller supply, two 100,000-ohm, 25-watt resistors were used in parallel to obtain the 50,000 ohms required. (While “Dividohms” were used because they were readily available at the time, fixed resistors will serve, of course.) This method doubles the power rating and provides a measure of safety in the event one of the resistors burns out.

Of course, the larger the resistance, the smaller the wire used in a resistor—and the more prone it is to burn out. Frankly, we prefer the second method—employed in the 1500-volt supply—of using two 50,000-ohm, 50-watt resistors in series to obtain the 100,000 ohms of resistance necessary in this power supply. This, too, doubles the power rating and provides as large wire as feasible.

A multitude of refinements can be made on a power supply, of course—one of the most worth while being a safety interlock arrangement in the final installation. However, outside of including fuses, switches and pilot lamps in the accompanying circuit diagrams, refinements have been left to the individual builder to include as suits his purpose. In deviating from the power supplies described herein, however, care should be taken to insure proper insulation at all points.

Wire with insulation suitable for the voltage involved should be used not only in the power supply unit itself, but also in making inter-unit connections to control panels and transmitters. Adequate mechanical strength should be maintained in the mounting of the heavy transformers and chokes. Input and output connectors can be of any type suitable for the voltages concerned.

The two switches included in the diagrams permit separate control of the rectifier filament power and plate power. The first time the supply is used, a filament warm-up of at least one minute is recommended before applying plate power. This will allow the mercury within the GL-816 tubes to distribute itself properly. This also applies whenever the tubes are removed and replaced. In subsequent operation, it is necessary to allow at least ten seconds for heating the filaments before applying plate power. The power supply should be operated only when the tubes are in a vertical position.

When operated within ratings, these power supplies should give the builder the most satisfactory performance ever experienced with any power supply.

One more thing: **DON'T LOAD THE POWER SUPPLY WITH YOUR BODY!** Be certain to short-circuit the output terminals before working on anything connected with the supply—even when it is turned to the “OFF” position and even if the a-c line cord is pulled out. Remember that 100 microfarads of capacity will hold a lot of “soup” and a burned-out bleeder will allow dangerous voltages to remain in the filter for a matter of *minutes* after it is turned off!

NATIONAL CALLING AND EMERGENCY FREQUENCIES

C.W.

3550 kc 14,050 kc
7100 kc 21,050 kc
28,100 kc

'PHONE

3875 kc 14,225 kc
7250 kc 21,400 kc
29,640 kc

During periods of communications emergency these channels will be monitored for emergency traffic. At other times, these frequencies can be used as general calling frequencies to expedite general traffic movement between amateur stations. Emergency traffic has precedence. After contact has been made the frequency should be vacated immediately to accommodate other callers.

The following are the National Calling and Emergency Frequencies for Canada: c.w.—3535, 7050, 14,060; 'phone—3815, 14,160, 28,250 kc.

NATIONAL RTTY CALLING AND WORKING FREQUENCY

3620 kc

PARASITICS

In the “Designer's Corner” of the last issue of **G-E HAM NEWS** (Volume 9, No. 1) the formula for the resonant frequency should, of course, have read:

$$f = \frac{1}{2\pi\sqrt{LC}}$$

control unit

Somehow the problem of how to switch the rig and associated equipment on and off seems to sneak up on a fellow unsuspectingly. He concentrates on his transmitter, receiver, converters, VFO and the other pieces of equipment and when he gets them all working suddenly realizes he doesn't have any way to operate them without flipping a dozen or so separate switches.

Then he has to scramble around hunting in handbooks and magazines and calling up his friends to get ideas for a control unit of some sort. Of course, it's not a difficult problem, and there are endless ways of solving it.

We present this solution—found in the shack of W2GYV—as one more suggestion to add to the pile. This is a 7-inch control panel with a 4 x 17 x 3-inch chassis mounted as shown.

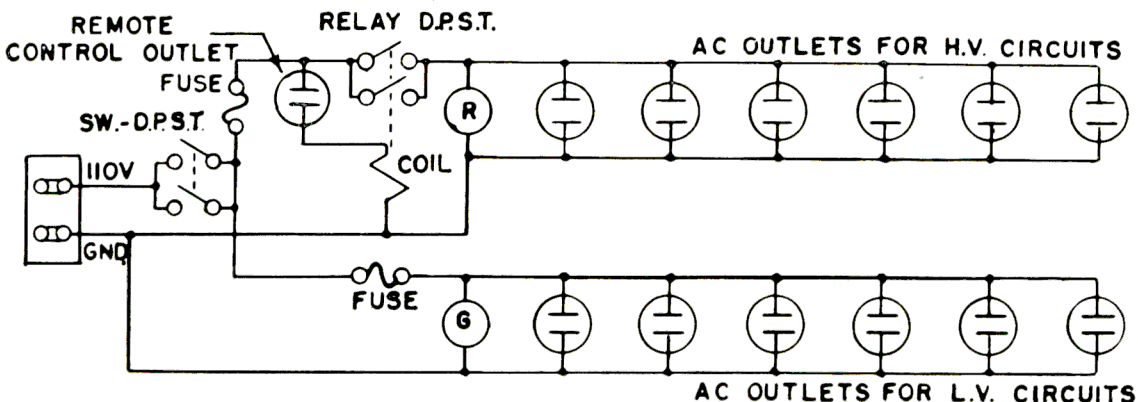
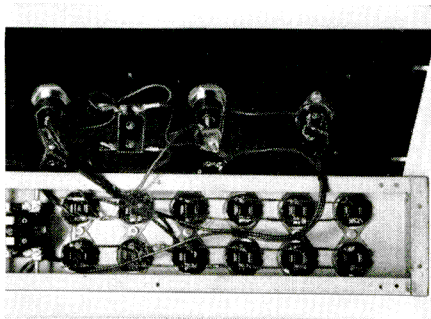

The circuit is simple and provides for remote control via the a-c type female outlet on the front of the panel. On the rear of the unit are two rows of a-c outlets—both supplying 110-volt a-c. The bottom row of six outlets is controlled by the front panel switch and is used for filament circuits in other pieces of equipment. The top row of outlets is controlled by the same switch plus the relay, and offers 110-volt a-c for the high-voltage plate transformers of various pieces of equipment.

An interesting feature of the circuit is that the relay coil is connected in the grounded side of the 110-volt a-c circuit. This method of connecting the coil eliminates any possibility of the relay being actuated if the hot lead in the remote control cable should accidentally become grounded. Incidentally, the relay used here is a double-pole type to provide a wide margin of current-carrying capacity and to halve the possibility of poor contact because of dirt or corrosion. A single-pole relay can be used.

The toggle switch shown is a heavy-duty, double-pole type to insure plenty of current-carrying capacity. The fuses used should be chosen to just carry the total current that will be drawn in their respective circuits.

The photographs show the construction clearly. Note that the mounting plates for the a-c outlets are overlapped to fit neatly in the chassis. Nothing in the construction is critical and the builder can make whatever variations are necessary to suit his purpose.

One excellent feature to add would be an interlock switch in series with the remote control outlet.

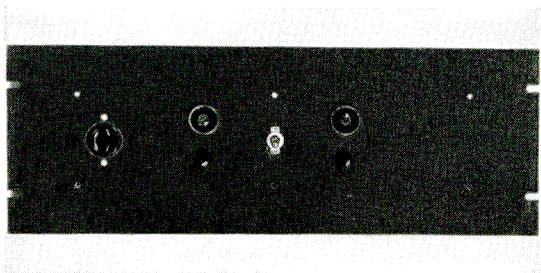
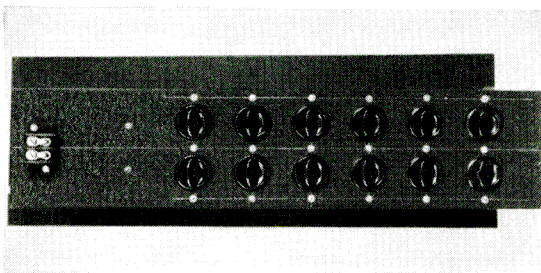

SWEEPING *the* SPECTRUM

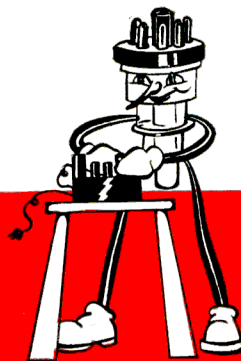
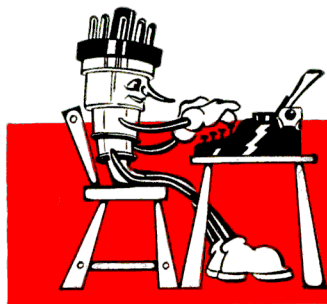

While we were working on the power supplies described in this issue, the editor stopped by and made a few comments inspired by our ideas on doubling the bleeder resistors.

"I'll bet a lot of fellows don't realize how dangerous a bleeder resistor can be," he said. "It gives a person a false sense of security, and he forgets or at least never truly realizes that a burned-out bleeder can leave his power supply filter set up like a baited trap—ready to knock the unwary for what might very well be his last loop.

"It may sound corny and trite," he went on. "But write up that safety angle just as strong as you can. I was lucky. I learned the easy way. One time I had borrowed a power supply and in hooking it up had occasion to turn it upside-down and work on the output connection. Of course, I shut off the switch and then—purely out of habit—I shorted the output with a screwdriver. I'd developed this habit because I hadn't been using a bleeder—not because I was afraid of a burned-out bleeder.

"Well, there was an arc, a big one. I thought nothing of it for a moment. Then I saw the supply had a bleeder and it occurred to me that there shouldn't have been any arc. I checked the bleeder. Sure enough, it was open.

"Before that happened I'd considered the possibility of an open bleeder purely academic, and I'd merely given lip service to safety. But that arc was plenty real and since then—well, I'm still here.

"While you're about it, Larry, you might write in a couple more things about safety . . . about keeping one hand in your pocket when you adjust live equipment . . . standing on a dry floor . . . or better, don't adjust live equipment.

"Don't mind if some of the boys say it's old stuff. Spare a few lines of type on a plea for safety—and maybe save a life."

So, fellows, when working on these power supplies or anything connected with them, keep a sort of mental red neon sign flashing in your mind—a sign that reads: "DANGER—HIGH VOLTAGE."

✱ ✱ ✱

Beginners often ask: "What should I start out with for a transmitter?" It's a simple question, seemingly, but after I start thinking about it I feel about as confused as the fellow who asked the question.

Perhaps the answer is that there is no general answer at all. Checking with the fellows around here shows that it all depends on circumstances what you start out with in ham radio. A few of the lads, presumably

born in a gold mine, began with rather expensive commercially built rigs. At the other extreme are fellows who dismantled old broadcast receivers and built low-power rigs from the parts. Some of the boys started as Jr. OP's, cut their eyeteeth on the old man's discarded B batteries, and apparently had all the necessary parts available to begin to put things together as soon as they were big enough to lift a soldering iron. Then, of course, there's the bunch who started out with a great big zero in the way of either tools or equipment. And you know, they weren't so bad off in the end because while they were scrimping and saving to buy some tools and parts, they had plenty of time to think things all over, visit other hams and decide what they really wanted—instead of rushing out and buying, in their ignorance, a white elephant.

Most fellows seem to want a bandswitching rig. But this has two disadvantages. A compromise in performance almost always is unavoidable. Also, the chances are high that a good part of the circuitry will never be used to full advantage—thus a fair share of the investment will be wasted.

The advice of two of the lads I talked this problem over with is for the beginner to start out on just one band with a small transmitter—preferably a CW rig. They point out that this opens the way to a lot of fun and experience for not too much money. Of course, it is agreed that eventually the beginner who does this will want to try other bands and various types of modulation.

A lot of fellows end up with several small rigs—each for a separate band or mode of operation. And if they are not interested in more than 100 watts, they are very happy. Other fellows sell or swap their first small rigs and go into higher power for keeps.

Everyone I've talked to about this problem has agreed on one thing, however: It takes just as much or more time to decide what you want to do, as it does to do it. So you fellows who are worrying because you spend so much time wondering what to build can stop worrying. Your condition is normal. Take your time and plan carefully. It'll save you money in the end.

✱ ✱ ✱

First edition of the WVARA NEWS, published by the Wabash Valley Amateur Radio Association of Terre Haute (W9QPD, secretary) has appeared. It contains news notes of members, a YL section, a feature spotlighting one of their novices (WN9AWW), and a Trading Post section. Congratulations, fellows, on the new bulletin.

—*Lighthouse Larry*

BEAM POWER PENTODE

Amateurs looking for a power tube with high-current-low-voltage characteristics for use in low-power RF-applications may find the 6AV5 of special interest. While designed for use as a horizontal deflection amplifier in TV receivers, it should outperform the 6L6 when properly used as a buffer, multiplier or final amplifier. The tube served excellently as a clamp modulator in the 6-meter rig described in G-E HAM NEWS, Volume 7, No. 1. It is an octal base GT tube with a 6.3-volt a-c or d-c filament drawing 1.2 amperes.

BASING DIAGRAM

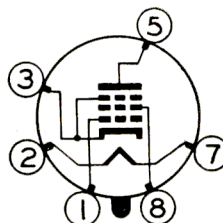

Bottom View

RATINGS AND CHARACTERISTICS

	Maximum	Average
Plate voltage	550 volts	250 volts
Screen voltage	200 volts	150 volts
Control grid voltage	-100 volts	-22.5 volts
Plate dissipation	11 watts	—
Screen dissipation	2.5 watts	—
Plate current	100 milliamperes	.55 milliamperes
Screen current	—	2.1 milliamperes
Transconductance	—	.5800 micromhos



Ham News

Available FREE from

G-E Electronic Tube Distributors

A Bi-monthly Publication

TUBE DEPARTMENT

GENERAL ELECTRIC

Schenectady 5, N. Y.

In Canada, Canadian General Electric Company, Ltd., Toronto, Ont.

S. E. McCALLUM, W2ZBY—EDITOR